

Meyer
PATHPRO²

OWNER'S MANUAL
AND
USER'S GUIDE

AMERICA'S
BEST
WARRANTY

1
YEAR



Read the PathPro2 Owner's Manual before operating or servicing a snow plow.
FOLLOW THESE INSTRUCTIONS EXPLICITLY.

Thank You

Thank you for buying the PathPro2 By Meyer. As a new owner of hard-working, mechanical equipment, we strongly urge you to spend quality time with this owner's manual. It's easy to use and full of time-saving tips that will enhance your ownership experience. It includes suggestions for faster installation, safe operation and more productive plowing.

We also strongly urge you to register your new HomePlow at thehomeplow.com. Registering will only take minutes and the benefits of doing so will last for years. When registered, you will receive timely and accurate communication on operation tips, maintenance, new products, and service bulletins. And in the unlikely event you need warranty work done, your local servicing dealer will be able to process your claim faster.

Thanks again for your business. You can now look forward to many years of reliable performance and keeping your driveway safer and easier to use. If you have any questions about your PathPro2, contact us at: www.thehomeplow.com

Sincerely,

Customer Service
HomePlow by Meyer
18513 Euclid Avenue
Cleveland, Ohio 44112
877-412-PLOW (7569)



Table of Contents

Subject	Page
Safety	3-4
Registration Data Sheet	5
Introduction	5
Snow Plow Assembly	6-22
Wiring Installation	23-26
Attach Plow	27
Remove Plow	28
How To Plow	29
Pre-Season & Post-Season Maintenance	30-31
Manual Lift Parts Lists	32-33
Electric Lift Parts List	34-35
Troubleshooting Guide	36
HomePlow Accessories	37
Warranty	38

SAFETY DEFINITIONS



This is the safety alert symbol. It is used to alert you to potential personal injury hazards. Obey all safety messages that follow this symbol to avoid possible injury or death.



DANGER Indicates an imminently hazardous situation which, if not avoided, will result in death or serious injury.

















WARNING Indicates a potentially hazardous situation which, if not avoided, could result in death or serious injury.











CAUTION Indicates a potentially hazardous situation which, if not avoided, may result in minor or moderate injury.



CAUTION used without the safety alert symbol indicates a potentially hazardous situation which, if not avoided, will result in property damage.

1		Never stand or ride on the plow assembly. Keep people and pets at least 25 feet away from the snow plow when in operation. Failure to comply will result in death or serious injury.
2		Insert and lock locking pin securely before using. Not doing so will result in serious injury or death. It can also result in damage to the vehicle and/or plow.
3		Always lower moldboard to the ground when snow plow is being serviced or when vehicle is not in use. Failure to comply could result in death or serious injury.
4		The HomePlow is for driveway plowing only and should be used on ½-ton and smaller vehicles. Use of this product on larger than ½-ton vehicles is prohibited and can result in damage to the vehicle or plow. Failure to comply could result in death or serious injury.
5		NEVER use the HomePlow without first CAREFULLY reading the Owner's Manual. It is CRITICAL for your safety to ALWAYS obey EVERY warning in the manual and follow EVERY instruction EXPLICITLY. Failure to comply could result in death or serious injury.
6		The HomePlow by Meyer should be used by drivers with a valid operator's license. Keep all body parts inside the vehicle. Failure to comply could result in death or serious injury.
7		To prevent accidental movement of the plow, always turn off the controller whenever the plow is not in use. Failure to comply could result in death or serious injury.
8		The HomePlow should NEVER be used for ANY other purpose other than plowing snow on a driveway, using The HomePlow for other purposes could result in serious injury or death.
9		Inspect plow assembly and mounting components and fasteners for wear and damage before and after each use. Worn or damaged components or fasteners could allow the plow to drop unexpectedly. Failure to comply could result in death or serious injury.
10		Do not change plow position while traveling. You could suddenly lower the plow accidentally. Failure to comply could result in death or serious injury.
11		ALWAYS wear a seat belt when plowing snow. Hidden obstructions can cause the vehicle to stop suddenly resulting in personal injury. Failure to comply could result in death or serious injury.
12		Do not mix different kinds of hydraulic fluid. Some fluids are not compatible and may cause performance problems and product damage Failure to comply could result in death or serious injury.
13		NEVER perform any repairs or maintenance with the plow controller turned on and the plow plugged into the vehicle harness and the plow attached to the vehicle. Failure to comply could result in death or serious injury.
14		The vehicle must not be operated when overloaded. In all cases, the loaded vehicle weight, including the entire snow plow system, all aftermarket accessories, driver, passenger, options, nominal fluid levels, and cargo must not exceed the front/rear Gross Axle Weight Rating (GAWR), and total Gross Vehicle Weight Rating (GVWR). These weights ratings are specified on the safety compliance certification label on the driver's side door opening. The use of rear ballast weight may be required to prevent exceeding the front GAWR. Failure to comply could result in death or serious injury.
15		Read the HomePlow Owner's Manual before operating or servicing a snow plow. FOLLOW THESE INSTRUCTIONS EXPLICITLY. Failure to comply could result in death or serious injury.
16		SAFETY PRECAUTIONS should be used when Hydraulic Unit is in OPERATION and plow is in a RAISED position. Lower plow to ground when vehicle is PARKED in case of hydraulic failure. Failure to comply could result in death or serious injury.

17	 WARNING	Remove Plow Assembly before placing vehicle on hoist/lift. Failure to comply could result in death or serious injury.
18	 WARNING	Do not exceed 10 mph transporting plow. Do not exceed 5 mph plowing snow. Know your road conditions at all times. Keep feet clear of moldboard at all times. Failure to comply could result in death or serious injury.
19	 WARNING	SAFETY PRECAUTIONS should be used when Hydraulic Unit is SERVICED. Hydraulic fluid under pressure can cause skin injection injury. If you are injured by hydraulic fluid, get medical attention immediately. Failure to comply could result in death or serious injury.
20	 WARNING	Vehicle exhaust contains lethal fumes. Breathing these fumes, even in low concentrations, can cause death. Never operate vehicle in an enclosed area without venting the exhaust to the outside. Failure to comply could result in death or serious injury.
21	 WARNING	Gasoline is highly flammable and gasoline vapor is explosive. Never smoke while working on vehicle. Keep all open flames away from gasoline tank and lines. Wipe up any spilled gasoline immediately. Failure to comply could result in death or serious injury.
22	 CAUTION	Flag obstructions that are under snow to prevent damage to product or property. Failure to comply may result in minor or moderate injury.
23	 CAUTION	A ballast weight may be required to prevent front GAWR overloading. If required, ballast must be securely attached at least 24 inches behind the rear axle. Failure to comply will result in property damage.
24	 CAUTION	Batteries normally produce explosive gases which can cause personal injury. Therefore, do not allow flames, sparks or lit tobacco to come near the battery. When charging or working near a battery, always cover your face and protect your eyes, and also provide ventilation. Batteries contain sulfuric acid which burns skin, eyes and clothing. Failure to comply will result in property damage.
25	 CAUTION	See your HomePlow Authorized Distributor/Web site for specific vehicle application recommendations before installation. Failure to comply will result in property damage.
26	 CAUTION	Installation of a snow plow may affect your new vehicle warranty. For more information consult your Vehicle Owner's Manual / Vehicle Dealer. Failure to comply will result in property damage.
27	 CAUTION	Warranty does not apply to a HomePlow product which has been negligently or improperly assembled or installed. Failure to comply will result in property damage.
28	 CAUTION	CAUTION: To avoid harm to vehicles electrical system always disconnect battery before beginning installation. DO NOT BURN holes or WELD vehicle frame. This may cause frame failure. Failure to comply will result in property damage.
29	 CAUTION	A driver's first responsibility is the safe operation of the vehicle and snow plow. The most important thing you can do to prevent a crash is to avoid distractions and pay attention to the road. Wait until it is safe to operate mobile communication equipment such as cell phones, two way radios, etc. Failure to comply will result in property damage.
30	 CAUTION	Front end wheel alignment and headlight aim may require readjustment after installation of equipment, and is the responsibility of the equipment installer. Failure to adjust front wheel alignment may cause premature uneven tire wear. If required, reset to chassis manufacture's specifications. Failure to comply will result in property damage.

SAFETY DEFINITIONS



This is the safety alert symbol. It is used to alert you to potential personal injury hazards. Obey all safety messages that follow this symbol to avoid possible injury or death.



DANGER Indicates an imminently hazardous situation which, if not avoided, will result in death or serious injury.



WARNING Indicates a potentially hazardous situation which, if not avoided, could result in death or serious injury.



CAUTION Indicates a potentially hazardous situation which, if not avoided, may result in minor or moderate injury.



CAUTION used without the safety alert symbol indicates a potentially hazardous situation which, if not avoided, will result in property damage.

Introduction

The PathPro2 has published this manual to help you get maximum performance from your snow plow and familiarize you with the features designed for efficiency and safety; be sure you recognize and understand them. Follow recommended operation and maintenance instructions, so when the storm hits, your PathPro2 will be ready and you will know how to plow like a pro. **WARNING: Deployment of an air bag while using a The PathPro2 will not be covered under The PathPro2's warranty.**

In conjunction with FMVSS (Federal Motor Vehicle Safety Standards) and OEM (Original Equipment Manufacturer) guidelines, The PathPro2 has designed this plow pack.

We also strongly urge you to register your new PathPro2 at thehomeplow.com. Registering will only take minutes and the benefits of doing so will last for years. When registered, you will receive timely and accurate communication on operation tips, maintenance, new products, and service bulletins. And in the unlikely event you need warranty work done, your local servicing dealer will be able to process your claim faster.

Vehicle requirements: Two or Four wheel drive SUV/Pick-up type vehicle 1/2 ton or smaller including Utility Vehicles. Use on vehicles greater than 1/2 ton is prohibited. Minimum 60 Amp alternator. Minimum 70 Amp Battery (550CCA/Cold Cranking Amps). Must be able to accept a front 2" category 3 receiver hitch. Front suspension must be able to handle 250 lbs. of added weight of plow and hitch. Stock vehicle with no suspension modifications (lift kits) that have modified the height of the vehicle.

Hitch Requirements: Category 3 2"x2" front receiver. 300lb. Tongue weight rating – 3000lb. pull rating

Under the continuing HomePlow Improvement Plan, The HomePlow reserves the right to change design details and construction without prior notice and without incurring any obligation.

Registration Data Sheet

Register your snow plow at www.thehomeplow.com

Owner Name _____

Address _____

City _____

State/Province _____ Zip/Postal Code _____

Purchased From Company Name _____

Contact Name _____

Address _____

City _____

State/Province _____ Zip/Postal Code _____

PhoneNumber (_____) _____

E-mail _____

Date Purchased _____

Vehicle Make _____ Vehicle Model _____

Vehicle Year _____ Vehicle VIN _____

Controller Part Number _____

Moldboard Serial number _____

Manufacturer of Hitch Mount _____

PLOW ASSEMBLY

3/4 box
3/4 ratchet
7/16 box
7/16 ratchet
9/16 box
9/16 ratchet
15/16 box
15/16 ratchet
10" adjustable wrench
1/2" box
1/2" ratchet
Channel locks

Tools Needed for Assembly

You will need the tools listed to assemble your PathPro2.
It should take less than one hour and will require two people for assembly.



Hardware Kits

Manual Plow Hardware Kit – Models 23100/23150

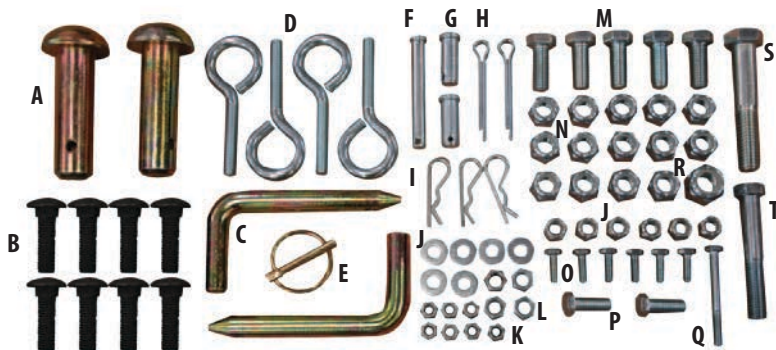

Electrical Plow Hardware Kit – Models 23200/23250

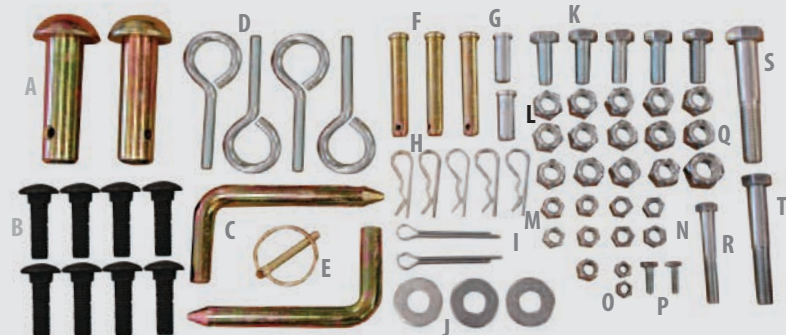

Manual Hardware

- A - Pin 1" x 3"
- B - 1/2-13 x 1-3/4"
- C - Hinge Pin
- D - Eyebolt 3/8-16 x 4"
- E - Lynch Pin
- F - Clevis Pin 3/8 x 3"
- G - Clevis Pin 1/2 x 1-1/4"
- H - Cotter Pin 1/4 x 2"
- I - Hair Pin Cotter 1/8"
- J - Locknut 3/8-16
- K - Locknut 1/4-20
- L - Finish Nut 3/8-16
- M - 1/2-13 x 1-1/4"
- N - Locknut 1/2-13
- O - 1/4-20 x 3/4"
- P - 3/8-16 x 1"
- Q - 1/4-20 x 2-1/2"
- R - Locknut 5/8-11
- S - 5/8-11 x 3-1/2"
- T - 1/2-13 x 3-1/4"

PLOW ASSEMBLY

Electric Hardware

- A - Pin 1" x 3"
- B - 1/2-13 x 1-3/4"
- C - Hinge Pin
- D - Eyebolt 3/8-16 x 4"
- E - Lynch Pin
- F - Pivot Pin 1/2 x 3"
- G - Clevis Pin 1/2 x 1-1/4"
- H - Hair Pin Cotter 1/8"
- I - Cotter Pin 1/4 x 2"
- J - Flatwasher 1/2"
- K - 1/2-13 x 1-1/4"
- L - Locknut 1/2-13
- M - Locknut 3/8-16
- N - Finish Nut 3/8-16
- O - Locknut 1/4-20
- P - 1/4-20 x 3/4"
- Q - Locknut 5/8-11
- R - 3/8-16 x 2-1/2"
- S - 5/8-11 x 3-1/2"
- T - 1/2-13 x 3-1/4"

A – Left Moldboard

B – Right Moldboard

C, D, E – Cutting Edges

F – Trip Springs

G – Compression Springs

H – Spacer Plate

I – Swing Arm, Spacer Tubes,
Pivot Arm

J – Spring Arm Covers

K - Manual Latch

L – Lift Frame

M – Plow Markers

N – A-Frame

O – Manual Handle

P – Manual Latch

Q – Manual Latch Weldment

R – Pivot Bar

S – Hardware Kit

T – Manual Leaf Spring

Manual Lift Plow – Models 23100/23150

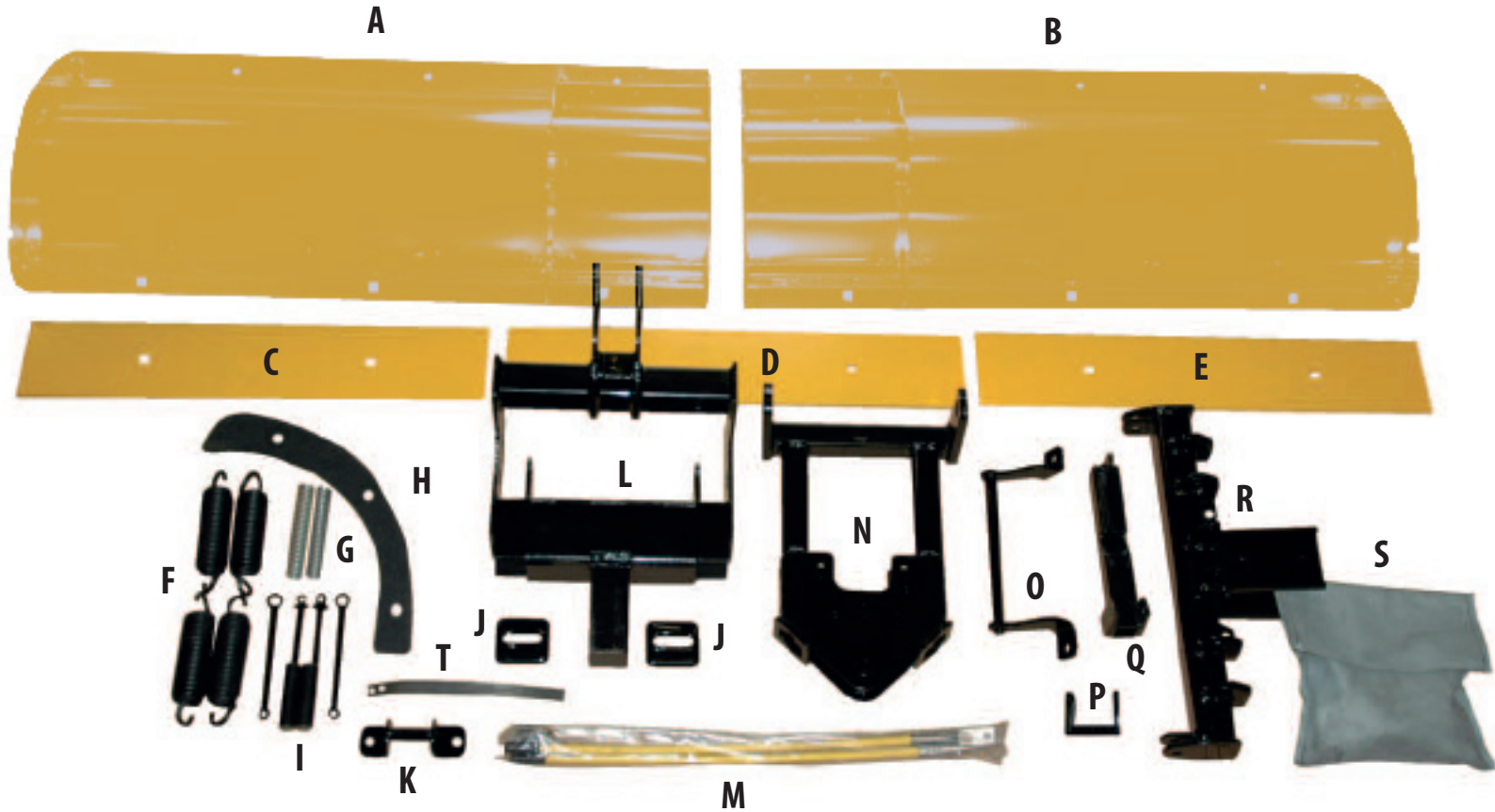

- | | |
|--|----------------------------|
| A – Left Moldboard | L – Lift Frame |
| B – Right Moldboard | M – Plow Markers |
| C, D, E – Cutting Edges | N – A-Frame |
| F – Trip Springs | R – Pivot Bar |
| G – Compression Springs | Q – Lift Arm |
| H – Spacer Plate | S – Hardware Kit |
| I – Swing Arm, Spacer Tubes,
Pivot Arm | T – Lift Chain |
| J – Spring Arm Covers | S – Hardware Kit |
| | U – Linear Actuator |

Electric Lift Plow – Models 23200/23250

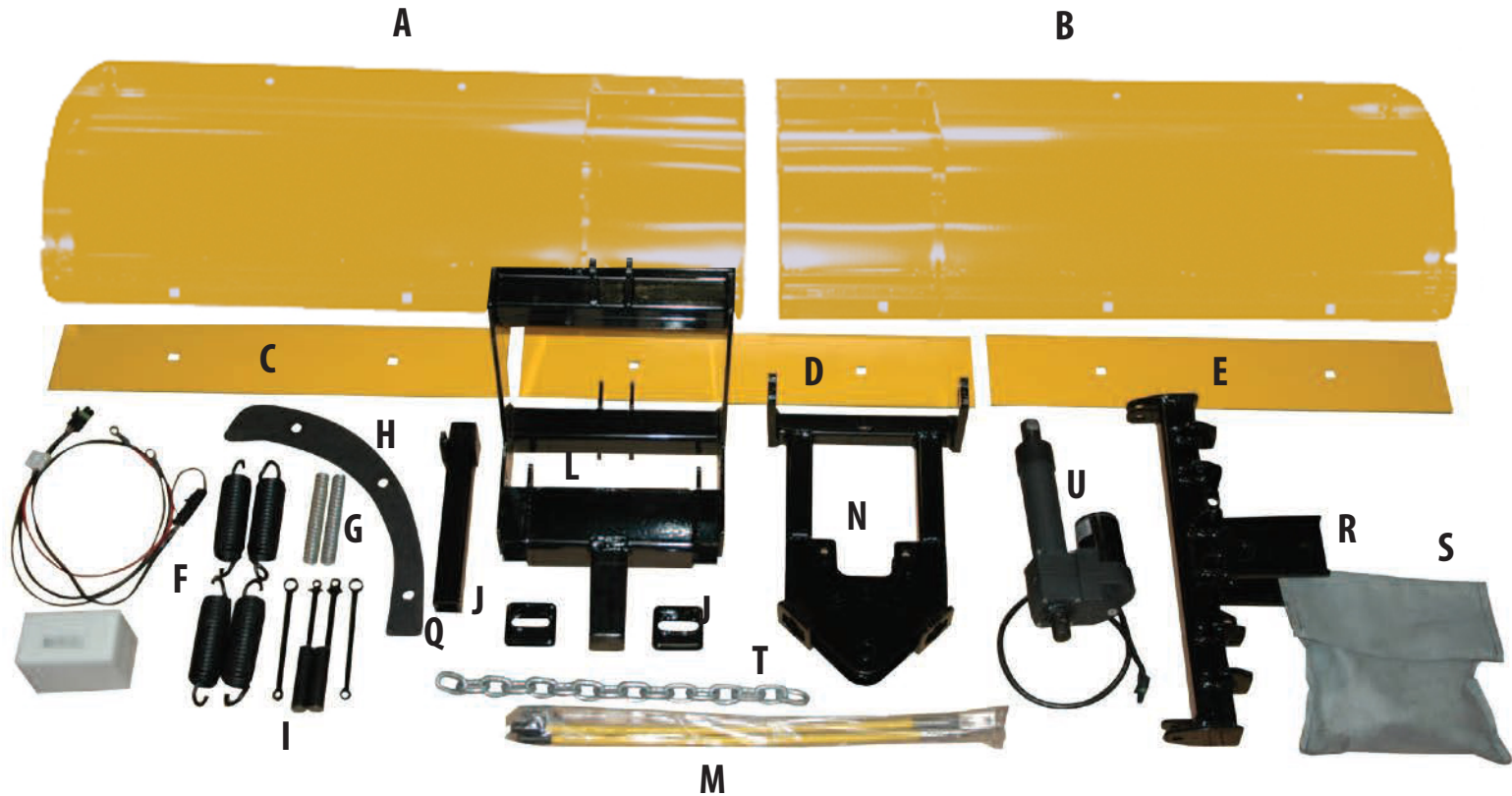

Moldboard and Pivot Bar Assembly

Parts Needed: A, B, C, D, E, H, R, S

1.

Sandwich spacer plate (H) between left and right moldboard assembly (A, B) using three 1/2-13 x 1-1/4" and 1/2" locknut. Tighten fasteners using a 3/4" box wrench and a 3/4" ratchet wrench.

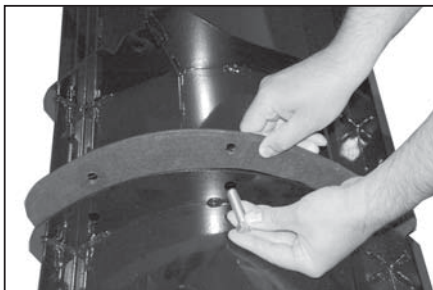

2.

Use eight 1/2-13 x 1-3/4" to align cutting edges (C,D,E) to left and right moldboard assembly. Fasten using 1/2" locknuts. Tighten fasteners using a 3/4" ratchet wrench.

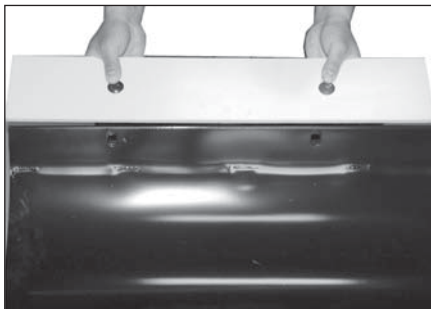

3.

Align pivot bar (R) to left and right moldboard assembly using two 1/2 x 1-1-1/4" clevis pins. Lock clevis pins by inserting two 1/8" hair pin cotter.

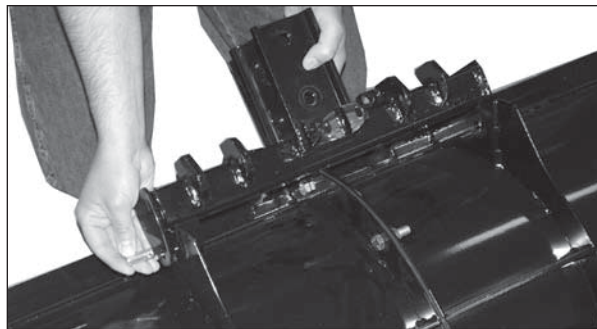

A-Frame Assembly

PLOW ASSEMBLY

Parts needed: I, G, N, R, S

4.

Assemble both sets of Spring arms and pivot arms (I) using 1/4-20 x 3/4" and 1/4-20 Locknut. Snug fasteners using a 7/16" box wrench and a 7/16" ratchet wrench.

NOTE: The Pivot and Spring Arms should be able to hinge.



5.

Drop the two spacer tubes (I) into the A-frame (N) as shown.



6.

Drop the two compression springs (G) into the A-frame (N) so they end up on top of the spacer tubes.



7.

Drop the two Pivot/Spring arm assemblies created in step (4) into the A-frame on top of the compression springs as shown.

NOTE: Long spring arm should face out.



8.

Snap the two spring arm covers (J) over A-frame (N) as shown.



A-Frame to Pivot Bar Assembly

PLOW ASSEMBLY

Parts Needed: R, S

9.

Attach the long Spring Arms (I) to Pivot Bar (R) using two 3/8-16 x 1" and 3/8-16 Locknuts. Snug fasteners using a 9/16" box wrench and a 9/16" ratchet wrench.

NOTE: The Pivot Bar and Spring Arms should be able to hinge.

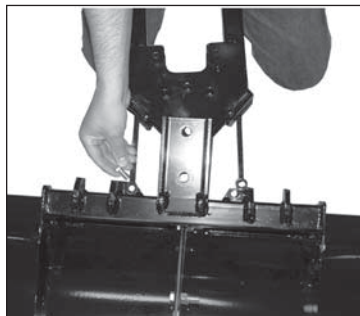

10.

Align A-frame (N) to Pivot Bar (R) and insert one 5/8-11 x 3-1/2" and 5" locknut. Snug fasteners using a 15/16" box wrench and a 15/16" ratchet wrench.

NOTE: The Pivot Bar and A-Frame should be able to hinge.

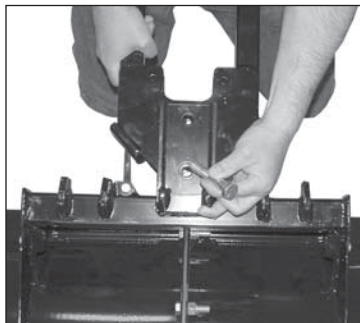

11.

Insert one hinge pin thru A-frame (N) and Pivot Bar (R) to lock the plow straight. This can be removed for auto angling or installed for fixing the plow straight or to the left and right angle.

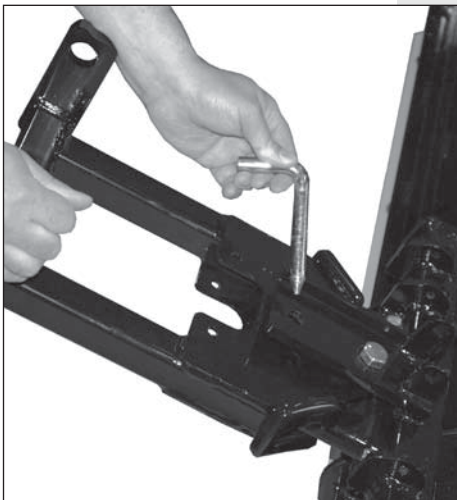

If you have the manual lift plow (Models 23100/23150) continue to Step 12; for electric lift models (23200/23250) go to step 24.

Pivot Bar/Trip Spring/Moldboard Assembly/Plow Markers

Parts Needed: F, K, M, S

12.

Align manual latch (K) under top plate of A-frame as shown. Attach latch by inserting two 3/8-16 x 1" and 3/8" Locknuts. Tighten fasteners using a 9/16" box wrench and a 9/16" ratchet wrench.

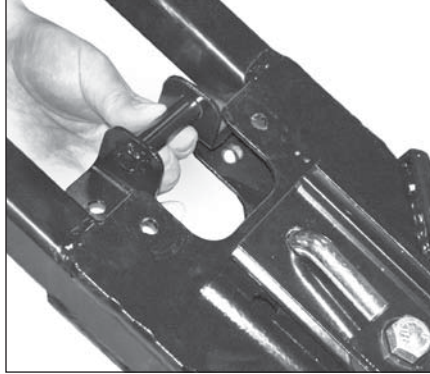

13.

Attach four trip springs to pivot bar as shown.

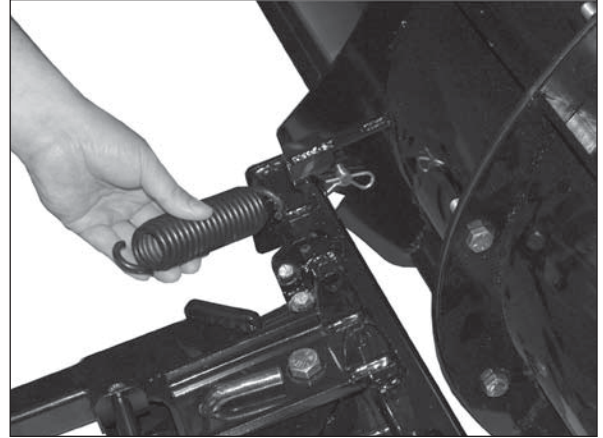

14.

Thread one 3/8-16 finish nut to each eyebolt all the way to the bottom. Attach eyebolts to each trip spring and slide eyebolt into the holes on the moldboard as shown. Fasten eyebolt to moldboard using 3/8-16 locknut.

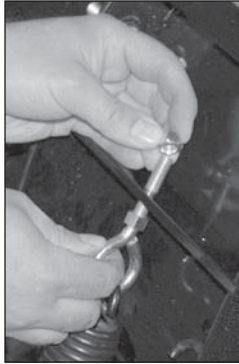

15.

Use a crescent wrench or pliers to hold the eyebolt in place and tighten 3/8-16 Locknut using a 3/8" ratchet. Tighten until a piece of paper can be placed in between the spring coils. Then bring up the 3/8-16 finish nut to lock eyebolt. Be sure the eyebolt is oriented correctly to allow the trip spring to hinge properly as shown.

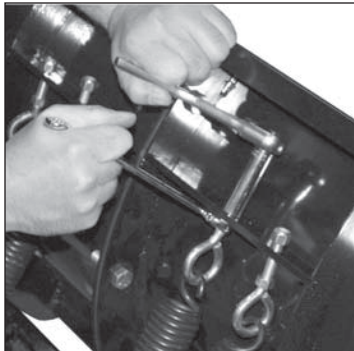

16.

Attach plow markers (M) to moldboard using four 5/16-18 x 1", 5/16" flatwashers and 5/16-18 locknut. Tighten using a 1/2" box wrench and 1/2" ratchet.

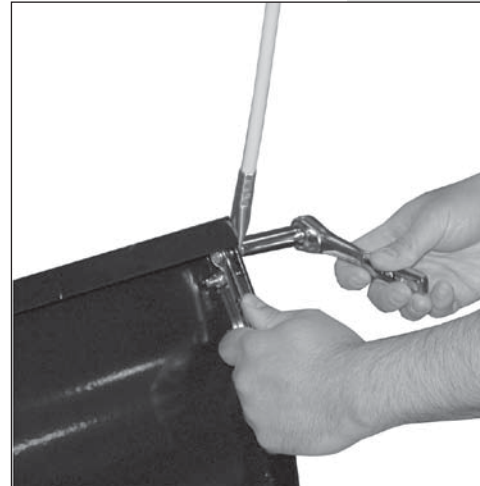

Manual Lift Assembly (Models 23100/23150)

Parts needed: L, O, P, Q, S, T

17.

Align lift frame (L) to A-Frame (N) by inserting two 1 x 3" pins. Lock pins using 1/4 x 2" cotter pins and bend cotter pins to lock into place.

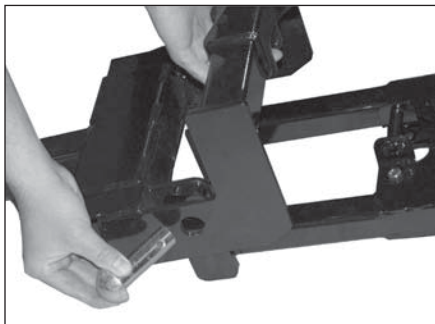

18.

Attach manual latch (P) to manual latch weldment (Q) using 1/4-20 x 2-1/2" and 1/4-20 locknut.



19.

Snug fasteners using a 7/16" box wrench and a 7/16" ratchet wrench. **NOTE: The manual latch rung lock and manual latch weldment should be able to hinge.**



20.

Attach manual leaf spring (T) to manual latch weldment (Q) using two 1/4-20 x 3/4", 1/4" flatwashers and 1/4-20 locknut. Tighten using a 7/16" box wrench and 7/16" ratchet.

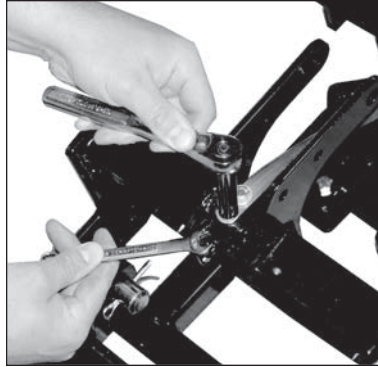

21.

Insert 3/8 x 3" clevis pin into lift frame at rear holes and insert one 1/8" cotter pin. Bend one end of cotter pin to lock into place.



Manual Lift Assembly (Models 23100/23150) (cont.)

22.

Bend back manual leaf spring (T) and insert manual latch weldment (Q) to lift frame (L). Attach using one 1/2-13 x 3-1/4" and 1/2-13 Locknut. Snug using 3/4" box wrench and 3/4" ratchet.

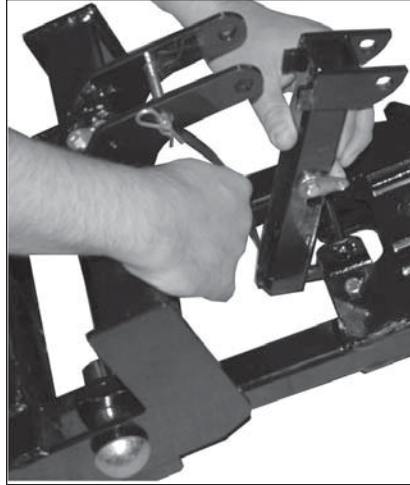

23.

Attach manual handle (O) to moldboard using two 1/4-20 x 3/4", 1/4" flatwashers and 1/4-20 locknut. Tighten using a 7/16" box wrench and 7/16" ratchet. Handle can be reversed for user preference.



You are now ready to enjoy your new HomePlow.

Electric Lift Assembly (Models 23200/23250)

PLOW ASSEMBLY

If you have an electric lift plow (Models 23200/23250) continue here from step 11.

Parts Needed:L, Q, S, T, U

24.

Align lift frame (L) and insert two 1 x 3" pins. Insert two cotter $\frac{1}{4}$ x 2" cotter pins and bend ends to lock into place.

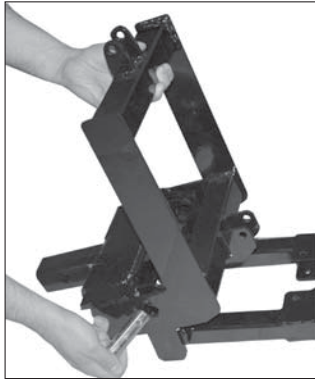

25.

Attach linear actuator (U) to lift frame using $\frac{1}{2}$ x 3" pin, $\frac{1}{2}$ " flat washer and $\frac{1}{8}$ " hair pin cotter.

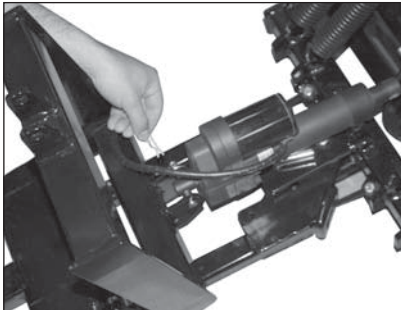

26.

Attach lift arm (Q) to lift frame (L) using $\frac{1}{2}$ x 3" pin, $\frac{1}{2}$ " flatwasher and $\frac{1}{8}$ " hair pin cotter.

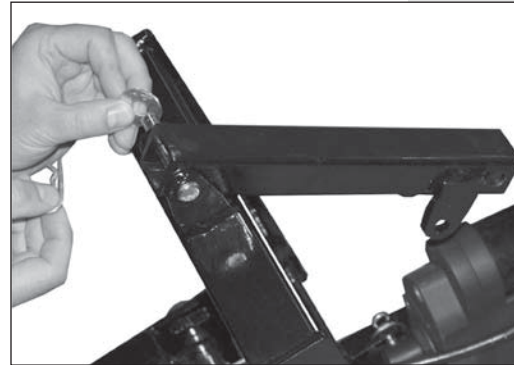

27.

Attach lift arm (Q) to linear actuator (U) using $\frac{1}{2}$ x 3" pin, $\frac{1}{2}$ " flatwasher and $\frac{1}{8}$ " hair pin cotter.

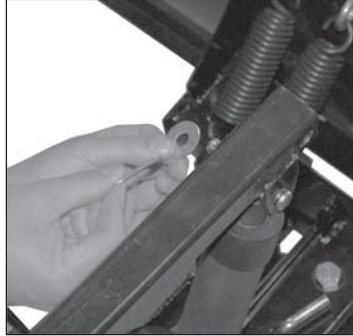

28.

Attach chain (T) to A-frame (N) using one $\frac{1}{2}$ -13 x 3-1/4" and $\frac{1}{2}$ -13 locknut. Tighten using $\frac{3}{4}$ " box wrench and $\frac{3}{4}$ " ratchet.

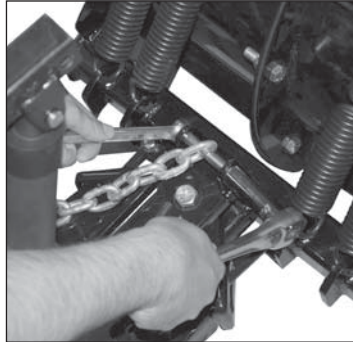

29.

Locknut. Tighten using $\frac{3}{4}$ " box wrench and $\frac{3}{4}$ " ratchet.

Note: Chain adjustment can be obtained by sliding more chain links into the Lift Arm. (See page 29)



You are now ready to enjoy your new HomePLOW.

WIRING INSTALLATION – Electric Lift Models 23200/23250 only

STEP 1

Carefully route the vehicle harness to the vehicle battery (fig. 12). You may need to route thru the grille or behind/under the bumper. Be sure to stay away from hot, sharp or moving parts of the vehicle and use the zip ties provided to secure. Attach the black wire to the negative (-) battery post (fig. 13) and the red wire to the positive (+) battery post (fig. 14). Coat connections with dielectric grease.



STEP 2

Add dielectric grease and carefully plug in receiver box (fig. 15 & 16). Carefully plug in receiver box and secure with zip ties (fig. 16). Be sure to stay away from hot, sharp or moving parts of the vehicle and use the zip ties provided to secure.



STEP 3

Install your receiver hitch mount (sold separately, see hitch requirements on pg. 4) per manufacturers instructions. Measure center of square hitch to the ground. This dimension (A) should be a minimum of 10" and a maximum of 13" (fig. 21). Measure from the hitch pin hole to the very end of your bumper. This dimension (B) should be not more than 8-1/2" (fig. 21). If your dimension does not fall within these ranges you should contact your hitch dealer/manufacturer for height or length adjustment accessories.

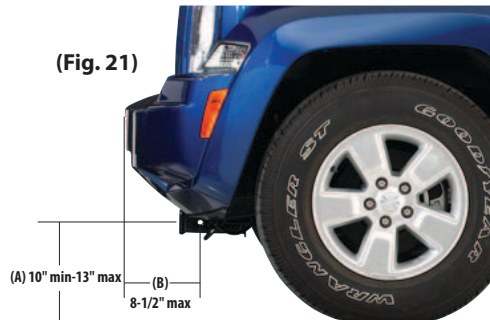

WIRING INSTALLATION – Electric Lift (cont.)

STEP 3: INSTALL PLOW ONTO VEHICLE

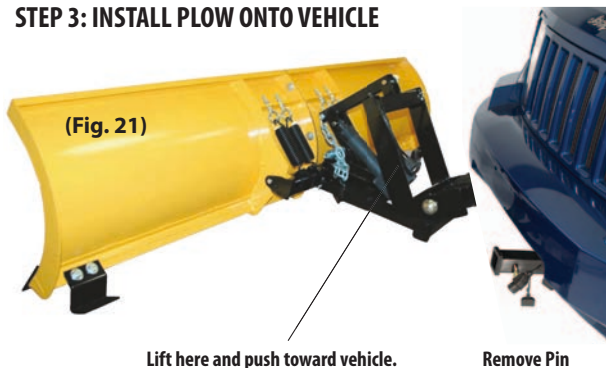

STEP 3a

Align vehicle so that the male tube on the lift frame is lined up directly in front of the receiver hitch (fig. 21). Lift slightly on the Lift Frame decal (fig. 22) and push plow assembly into the vehicle receiver hitch until the pin holes align (fig. 23). Proper install is shown in Figure 24.



STEP 4 (ELECTRIC LIFT)

Remove both weather cover from the end of the vehicle harness, add dielectric grease to the connecting prongs and connect. Reconnect weather cover to the vehicle harness once plow is removed.



STEP 5 (ELECTRIC LIFT)

If the plow utilizes the electric lift press "U" to Raise Plow and press "D" to Lower Plow.

Part #22891

Press the up arrow to raise the plow and the down arrow to lower the plow. A blue light will illuminate when either button is pressed. If it does not illuminate, the remote battery will need replaced. When using the electric lift, the raise and lower function will time out after 6 seconds of continuous up or down. When using the hydraulic unit, the raise function will time out after 3 seconds of continuous operation.

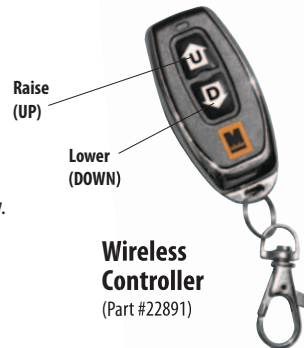

MANUAL LIFT

Models 23100/23150 only

Raise & Lower Plow (manual lift)



To raise the plow, lift plow by handle to the manual latch rung lock and then lower. This will lock the plow in the raised position. Then add safety pin.



To lower the plow, lift the plow by the handle up past the manual latch rung lock and then lower to the ground. The manual latch rung lock works just like an extension ladder.



Safety pin location for transporting plow

Safety pin location for operating plow



Safety pin

ATTACH PLOW TO VEHICLE

Remove Hitch Pin. Align the vehicle receiver hitch so that the male tube on the lift frame is lined up directly in front of the receiver hitch (fig. 30). Lift slightly on the Lift Frame decal (fig. 31) and push plow assembly into the vehicle receiver hitch until the pin holes align (fig. 32). Proper install is shown in Figure 34. Connect electrical plug (Models 23200/23250 only)(fig. 33).



(Fig. 31)



(Fig. 30)



(Fig. 32)

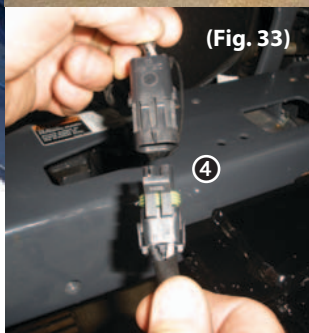

(Fig. 33)

- 1 Remove pin
- 2 Lift here and push toward vehicle
- 3 Re-install pin
- 4 Connect electrical plug
(Models 23200/23250 only)

(Fig. 34)



REMOVE PLOW FROM VEHICLE

Lower plow all the way down.
Disconnect electrical plug (Models 23200/23250 only) (fig. 41)
and install weather covers to both
end of the harness. Remove Hitch pin
(fig. 40). Gently lift at lift frame decal
(fig. 42) and slide lift frame out of
receiver hitch on vehicle (fig. 43).
Re-install Hitch pin thru Lift Frame.

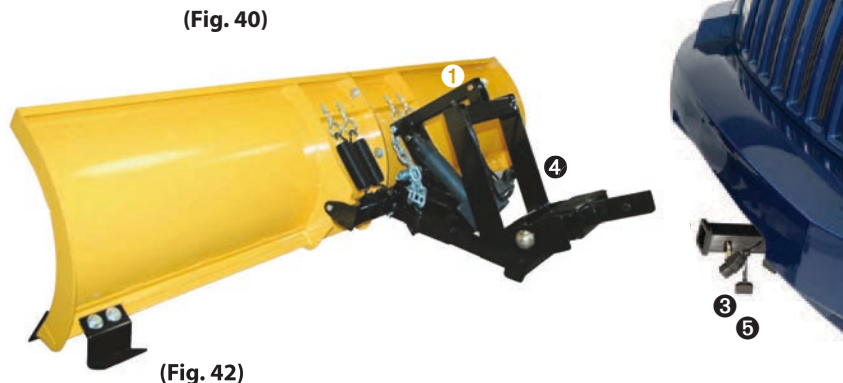

(Fig. 40)

(Fig. 42)

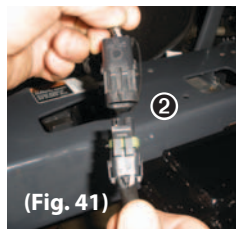

- 1 Push here to put slack in chain
- 2 Disconnect electric plug (Models 23200/23250 only)
- 3 Remove pin
- 4 Lift here and pull away from vehicle
- 5 Replace pin to plow hitch

HOW TO PLOW

Chain Adjustment (electric lift) (Models 23200/23250 only)

The chain is adjustable at the lift arm. The chain must be adjusted with the controller in the down (Float) position and the actuator must be all the way down as far as it will go. The chain should be adjusted to have 2-3 links of slack (see step 29, page 22). Also if a major electric actuator malfunction is experienced the plow can be raised by a floor jack or two people and the chain can be adjusted up with no slack. This will then suspend the plow above ground so the vehicle can be driven to your nearest HomePlow Service center.

Plowing

Always plow with the storm, every 2-3" of accumulation. The plow to automatically angle to the side with the heaviest amount of snow and when raised the plow will automatically return to the center or straight position (fig. 45). The plow also is equipped with a fixed angle pin (fig. 46) which can position the plow to the left or right. To use the fixed angle pin manually push the plow to the left or right and drop in the fixed angle pin and secure with the hair pin. Lift as high as possible, then drive through the snow to the garage. Drop the blade and back drag away from the garage. Turn around, back into the cleared path to the garage, set the blade in an angled position if necessary and continue rolling snow away from the house. Complete as many passes as necessary to clear the snow. The first storm of the season, plow back from the drive area to allow space to pile future snowfall.



(Fig. 44)



(Fig. 45)

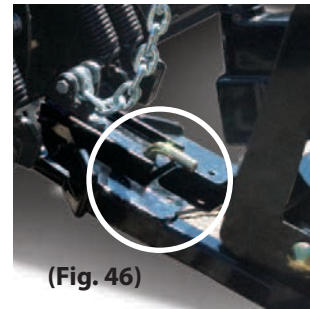

(Fig. 46)

PRE-SEASON & POST-SEASON MAINTENANCE

The HomePlow recommends this maintenance information for regular service. Sustained heavy operation may call for more frequent service. Snow plowing subjects a vehicle to exceptionally rugged use. As a result, it is very important to inspect and maintain the snow plow and vehicle up to maximum operating conditions.

Inspection should be made of both the vehicle and snow plow prior to the plowing season and after each use.

PRE-SEASON MAINTENANCE Scheduled vehicle maintenance should be performed as recommended by the manufacturer.

Don't forget that in addition to keeping equipment in order:

1. Keep windshield wipers, heaters and lights working.
2. Use emergency flasher lights for increased visibility and safety.
3. Equip vehicles with chains where necessary.

VEHICLE ELECTRICAL SYSTEM For maximum efficiency, the vehicle supporting the snow plow must be properly serviced. The system should consist of at least a 70 amp./hr. battery and a 60 amp alternator. Be sure to check regularly:

1. Battery terminals to assure they're clean and free of corrosion.
2. Electrical connections, to assure they're tight and corrosion free.
3. Battery must be in top operating condition.
4. Alternator and regulator, to assure maximum electrical output.

Check the Diagnosis chart Pre/Post Season Maintenance for advice on maintaining the unit.

1. ALWAYS LOWER MOLDBOARD TO THE GROUND WHEN SNOW PLOW IS BEING SERVICED OR WHEN VEHICLE IS NOT IN USE.

2. Before and after each season, Grease all pins and lubricate all pivot points with chassis lube.

3. CUTTING EDGE – Replace the cutting edge as soon as it is 3-1/2" (5" is new) Tall. This will prevent permanent damage to the moldboard (fig. 48).

4. ADJUSTING TRIP SPRING TENSION – Tighten top locknut 4 turns beyond the point when spring coils begin to separate. Tighten bottom locknut to hold eye bolt in position (fig. 49).

5. MOUNTING BOLTS – Retighten all mounting bolts after first snow plowing session and at regular intervals through the season.

6. SNO-FLO® POWDER COATING, both black and yellow, should be checked at the beginning and end of each season for any signs of rust.

If any exists, use Sno-Flo® powder coat touch-up available in spray cans.

NOTE: PROTECTION AGAINST RUST AND CORROSION.

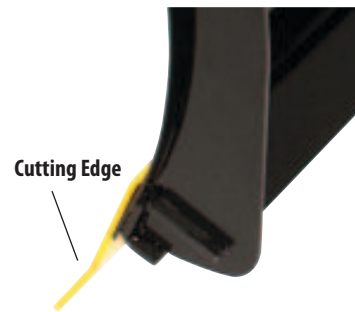

(Fig. 48)

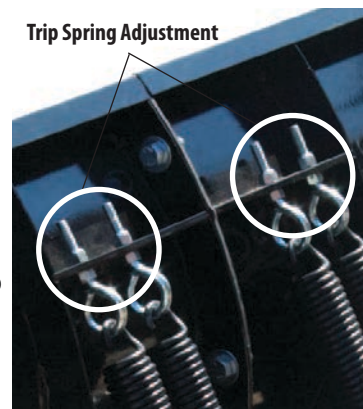

(Fig. 49)

POST-SEASON SUMMER MAINTENANCE

SNOW PLOW STORAGE

1. Coat pivot pin and other wear points with chassis lubricant. Be sure to grease all grease holes.
2. Unplug electrical connection. Coat connection with a dielectric compound to prevent corrosion and plug into their corresponding weather plug.

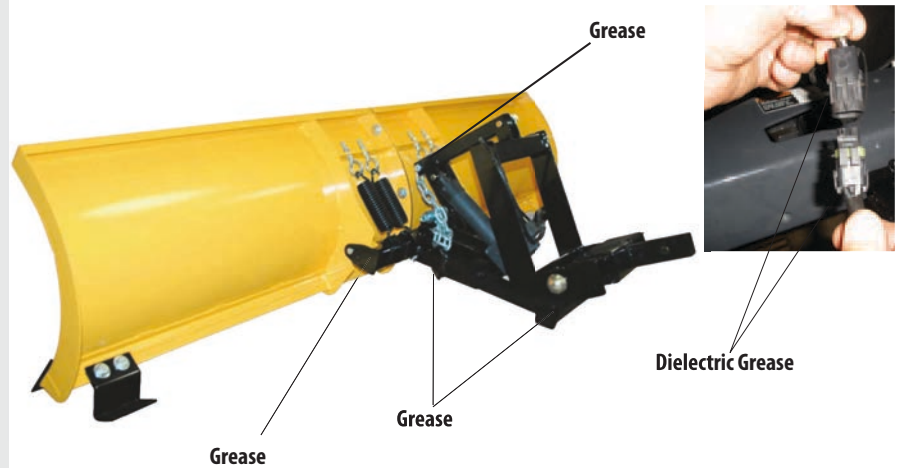

Available at www.thehomeplow.com



Protects your electrical system with Meyer winter formula dielectric grease.



Yellow and black paint is formulated to withstand harsh temperatures and the winter environment.

PARTS LIST

HOMEFLOW Manual Lift

ITEM	PART NO.	QTY.	DESCRIPTION
	23100/23150		HomeFlow Manual Lift
1	14001	1	• Lift Frame Assembly
2	13998	1	• A-Frame
3	13988	1	• Pivot Bar
4	09456	1	• Moldboard Assembly Right
5	13951	1	• Moldboard Assembly Left
6	09449YEL	1	• Cutting Edge Middle
7	09450YEL	2	• Cutting Edge Outer
8	08388	1	• Manual Lift Carton
9	13286	4	** Trip Spring
10	14016	1	** Manual Handle Assembly
11	14009	1	** Manual Latch Handle
12	14011	1	** Manual leaf Spring
13	14003	1	** Manual Latch Weldment
14	14007	1	** Manual Latch Rung Lock
15	14008	2	** Spacer Tube
16	13984	2	** Compression Spring
17	13986	2	** Spring Arm
18	13987	2	** Spring Arm Cover
19	13985	2	** Pivot Arm
20	09917	1	** Plow Marker Kit
	13969	1	** Spacer Plate
21	08956	1	** Hardware Bag
22	22851	4	*** Eyebolt 3/8-16 x 4"
23	20526	4	*** Finish Nut 3/8-16
24	20305	6	*** Locknut 3/8-16
25	20094	5	*** Bolt H 1/2-13 x 1-1/4" Gr. 5
26	20307	14	*** Locknut 1/2-13
27	21943	8	*** Bolt C 1/2-13 x 1-3/4" Gr. 5
28	22850	2	*** Clevis Pin 1/2 x 1-1/4"
29	22845	3	*** Hair Pin Cotter 1/8"
30	20147	1	*** Bolt H 5/8-11 x 3-1/2" Gr. 5
31	20309	1	*** Locknut 5/8-11
32	11101	2	*** Hinge Pin
33	22436	2	*** Pin 1 x 3"
34	20420	2	*** Cotter Pin 1/4 x 2"
35	22083	1	*** Lynch Pin
36	20102	1	*** Bolt H 1/2-13 x 3-1/4" Gr. 5
37	22942	1	*** Clevis Pin 3/8 x 3"
38	20003	6	*** Bolt H 1/4-20 x 3/4" Gr. 2
39	20351	6	*** Flatwasher 1/4"
40	20303	7	*** Locknut 1/4-20
41	20049	2	*** Bolt H 3/8-16 x 1" Gr. 2
	20019	1	*** Bolt H 1/4-20 x 2-1/2" Gr. 2

Parts indented are included in the assembly under which they are indented.

PARTS LIST

HOMEFLOW Manual Lift

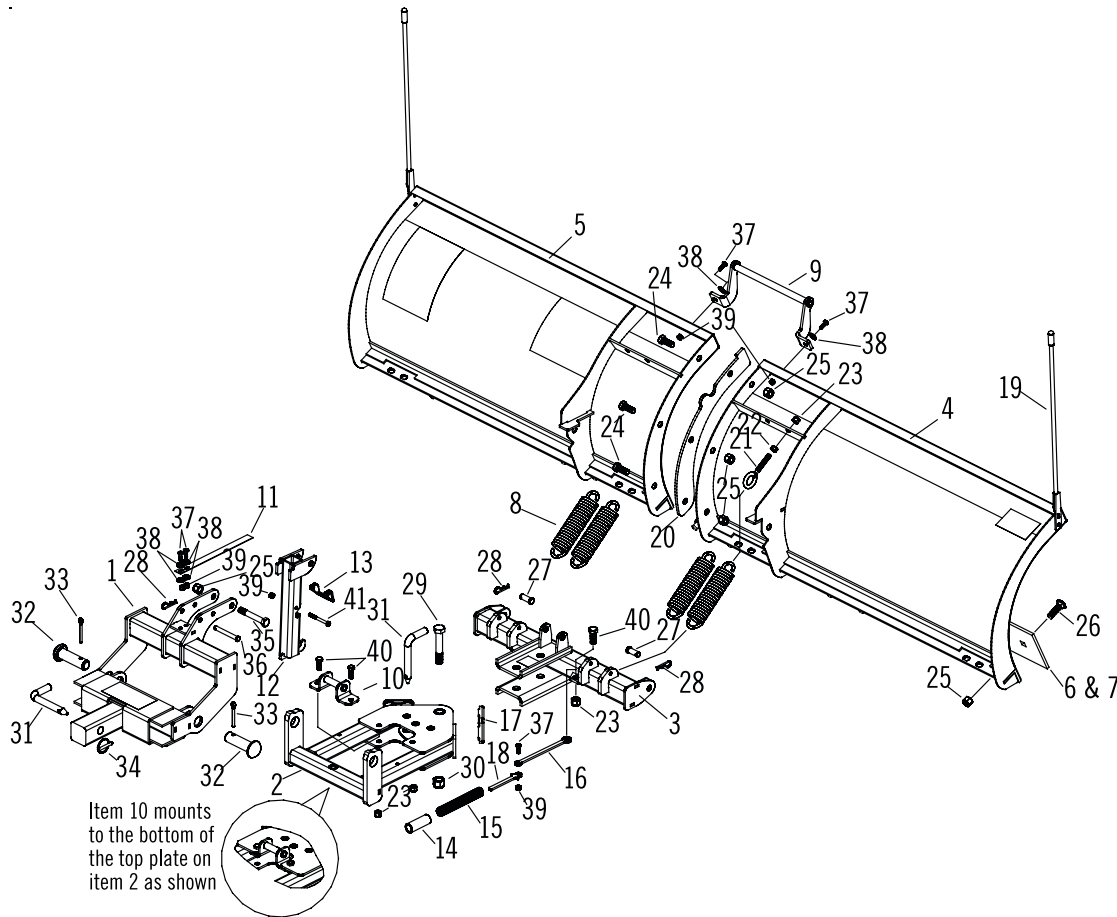

PARTS LIST

HOMEFLOW Electric Lift

ITEM	PART NO.	QTY.	DESCRIPTION
	23200/23250		HomeFlow Electric Lift
1	13994	1	• Lift Frame Assembly
2	13997	1	• Lift Arm
3	13998	1	• A-Frame
4	13988	1	• Pivot Bar
5	09456	1	• Moldboard Assembly Right
6	13951	1	• Moldboard Assembly Left
7	09449YEL	1	• Cutting Edge Middle
8	09450YEL	2	• Cutting Edge Outer
	08386	1	• Power Lift Carton
9	13286	4	** Trip Spring
10	22887	1	** Electric Lift
11	22888	1	** Electric Lift Harness
	22893	1	** Remote Control Kit
12	22891	1	*** Remote Controller
13	22894	1	*** Remote Control Receiver
14	09917	1	** Plow Marker Kit
15	13969	1	** Spacer Plate
16	13984	2	** Compression Spring
17	13986	2	** Spring Arm
18	13987	2	** Spring Arm Cover
19	13985	2	** Pivot Arm
20	14008	2	** Spacer Tube
21	21542	1	** Chain 5/16 x 20"
	08955	1	** Hardware Bag
22	22851	4	*** Eyebolt 3/8-16 x 4"
23	20526	4	*** Finish Nut 3/8-16
24	20305	5	*** Locknut 3/8-16
25	20094	5	*** Bolt H 1/2-13 x 1-1/4" Gr. 5
26	20307	14	*** Locknut 1/2-13
27	21943	8	*** Bolt C 1/2-13 x 1-3/4" Gr. 5
28	22850	2	*** Clevis Pin 1/2 x 1-1/4"
29	22845	5	*** Hair Pin Cotter 1/8"
30	20147	1	*** Bolt H 5/8-11 x 3-1/2" Gr. 5
31	20309	1	*** Locknut 5/8-11
32	11101	2	*** Hinge Pin
33	22436	2	*** Pin 1 x 3"
34	20420	2	*** Cotter Pin 1/4 x 2"
35	22083	1	*** Lynch Pin
36	20102	1	*** Bolt H 1/2-13 x 3-1/4" Gr. 5
37	22816	3	*** Pivot Pin 1/2 x 3"
38	20355	3	*** Flatwasher 1/2"
39	20003	2	*** Bolt H 1/4-20 x 3/4" Gr. 2
40	20303	2	*** Locknut 1/4-20
41	20068	1	*** Bolt H 3/8-16 x 2-1/2" Gr. 5

Parts indented are included in the assembly under which they are indented.

PARTS LIST

HOMEFLOW Electric Lift

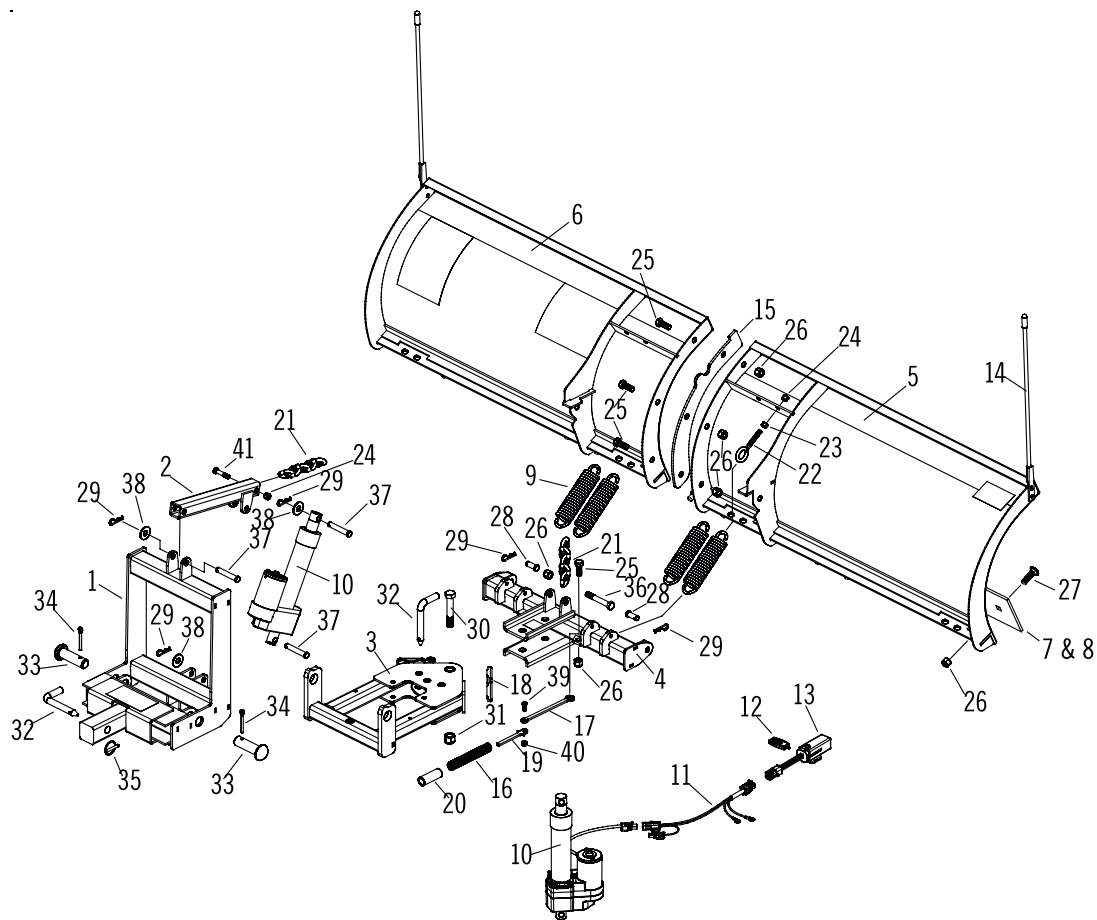

TROUBLESHOOTING GUIDE

Troubleshooting Guide for The PathPro2 Electric Lift (Linear Actuator)

CONDITION	POSSIBLE CAUSE	CORRECTION
Plow operates slowly	<ol style="list-style-type: none">1. Bad wire connections.2. Discharged battery.3. Bad Linear Actuator.4. Bad Remote Control Receiver.	<ol style="list-style-type: none">1. Clean/Tighten wire connections.2. Recharge battery.3. Replace Linear Actuator.4. Replace Receiver
Plow doesn't operate	<ol style="list-style-type: none">1. Bad wire connections.2. Discharged battery.3. Bad Linear Actuator.4. Bad Remote Control Receiver.5. Remote not communicating with receiver.6. Battery dead on Remote Control.7. Bad Remote Control.	<ol style="list-style-type: none">1. Clean/Tighten wire connections.2. Recharge battery.3. Replace Linear Actuator.4. Replace Receiver.5. Re-sync to receiver .6. Replace Battery and re-sync to receiver.7. Replace remote and re-sync to receiver.

Re-sync instructions:

1. Make sure receiver is plugged in and has 12 volts.
 4. Press the up and down button on remote simultaneously.
- The receiver is now communicating with the remote.



PathPro2 Snow Deflector

Made of pliable poly, the PathPro2 deflector keeps snow flume down and away from the windshield and accentuates the snow rolling action of the plow. It comes pre-drilled ready for installation.

Sold as complete kits and come ready-to-install with hardware bag and steel mounting belt.

Part #08267 (6'-8")



Meyer HotShot

An economical professional grade walk-behind spreader. Features a rust-proof polyethylene hopper, durable carbon steel frame and convenient flow controller. Delivers a 10' spread of salt or any free flowing granular material. A custom fit see-through hopper cover keeps material inside dry.

Part # 38115

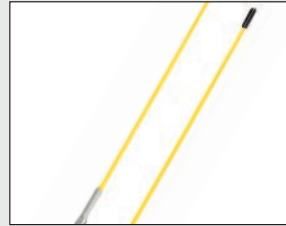

Replacement Plow Markers

Allow the operator to see the edge of their plow from the cab providing maximum visibility for increased performance and safety. Markers are pre-drilled to fit the moldboard, no drilling is necessary. Includes all mounting hardware and instructions for easy do-it-yourself installation.

Part #09917 (2 per set)



ACCESSORIES

THE PATHPRO2 SNOW PLOW LIMITED WARRANTY EFFECTIVE May 1, 2010

The PathPro2 warrants to the original purchaser of PathPro2 brand products that they will be free from defects in materials or workmanship for a period of one year from date of purchase to only the original owner.

This warranty does not cover:

- Problems caused by failure to follow the product instructions, failure to maintain the product as described in the Operator's Manual, or failure to maintain proper levels of lubricants;
- Damage resulting from rust, corrosion, freezing or overheating;
- Paint, or expendable snow plow parts such as pins, cutting edges, chrome plating and springs;
- Damage to any vehicle to which the products are mounted;
- Damage caused by usage that is not in accordance with product instructions, usage in an commercial or heavy duty environment (use of the snow plow for any purpose other than plowing snow is considered misuse and abuse);
- Any snow plow, or any part which has been modified or altered;
- Problems caused by using accessories, parts, or components not supplied by The HomePlow,
- Cost of tax, freight, transportation or storage charges, environmental charges, solvents, sealants, lubricants or any other normal shop supplies.
- Problems caused by collision, fire, theft, vandalism, riot, explosion, lightning, earthquake, windstorm, hail, water, flood, or any other Acts of God;
- Liability for damage to property, or injury to, or death of any person arising out of the operation, maintenance or use of the covered product;
- Products with missing or altered serial numbers;

The HomePlow will repair any product that proves to be defective in materials or workmanship. In the event repair is not possible or practical (as determined by The HomePlow in its sole discretion), The HomePlow will either replace the product with a new product of similar model and price, or refund the full purchase price, as determined by The HomePlow.

Customer must keep the HomePlow System serviced/maintained as recommended by The HomePlow. A written record of service must be maintained, along with receipts for maintenance materials purchased. A copy of the maintenance record and pertinent receipts may be requested in the event of a claim.

In order to obtain service under this warranty, the original purchaser must:

- Return the claimed defective part to any authorized The HomePlow Dealer, transportation and freight charges prepaid. Only The HomePlow Dealers are authorized to perform the obligations under this warranty. For the address and telephone number of The HomePlow Dealer nearest you, check the telephone directory, go to www.thehomeplow.com, write us at the address to the left, or call (877) 412-PLow (7569) for assistance;
- Provide maintenance record and receipts for required maintenance, if requested;
- Allow inspection of damaged parts and/or HomePlow System if deemed necessary by The HomePlow.
- It is the responsibility of the original purchaser to establish the warranty period by verifying the original delivery date. A bill of sale/sales receipt, cancelled check or some other appropriate payment record may be kept for that purpose.

EC DECLARATION OF CONFORMITY

The undersigned representing the manufacturer

and the authorized representative
established within the community

herewith declared that the Product: **Snow & Ice Equipment**

Model/Type ref.:

is in conformity with the Essential requirements of the following EC Directives when subject to correct installation, maintenance and use conforming to its(their)intended purpose, to the applicable regulations and standards, to our operation and maintenance manual.

2006/95/EC

EC Low Voltage Directive

2004/108/EC

EMC Directive

2006/42/EC

Machinery Directive

and that the Standards and/or technical specifications referenced below have been applied:

- ✓ BS EN 60204-1:2006 / IEC 60204-1:2005: Safety of machinery – Electrical equipment of machines-Part 1: General requirements.
- ✓ EN ISO 12100-1:2003:Safety of Machinery – Basic Concepts, General Principles of Design Part 1: Basic Terminology and Methodology
- ✓ EN ISO 12100-2:2003:Safety of Machinery – Basic Concepts, General Principles of Design Part 2: Technical principles
- ✓ EN 13021:2003+A1- Winter service machines - Safety requirements
- ✓ EN 61000-6-2: 2005. Generic standards – Immunity for Industrial Environments.
- ✓ EN 61000-6-4:2005. Generic emission standard, Part 2: Industrial environment.

Year of CE Marking:

Manufacturer:

Authorized Representative in the community:

Signature

Position JENNIFER M. MUMFORD

Date

5-14-2010

Place

CLEVELAND, OHIO

Signature

Position

Date

Place



THE PATHPRO2

18513 Euclid Avenue

Cleveland, Ohio 44112

877-412-PLOW (7569)

www.thehomeplow.com